

## **SIMULATION POWER FLOW ANALYSIS AND CONTINGENCY ANALYSIS BY USING POWER WORLD & MAT LAB ANALYSIS**

V.RUTH GRACE

P.KIRANMAI

B.RUPA

B.TECH 4<sup>th</sup> YEAR

Department of Electrical Engineering

AcharyaNagarjuna University college of Eng and tech

**GUIDER**

1.V.DEGA RAJAJI

Department of Electrical Engineering

2.J.SHIVA NAIK

Department of Electrical Engineering

### **ABSTRACT:**

*This paper presents an application of power world simulator for high quality electrical energy to the consumer in a secure & economic manner to provide optimal power to the consumer by using power flow analysis. The electric utilities face many problems in operation, planning & control of electric energy. Some of the important constraints are voltage security, environmental constraints with the consideration of these constraints the quality power will be supplied to the consumer with minimum pollution level and faults also occurred in the power system due to the transients present in the power system. The faults in the generator , transmission line ,whatever may be the equipment can be cleared by using Contingency Analysis . Same circuit is designed in MAT LAB analysis to determine the real and reactive powers values and voltage and current wave forms for each bus. The difference of power values obtained from power world and mat lab analysis have slight different. The power obtained from the power world is accurate and easy to understand also. So POWER WORLD is most convenient & accurate method to obtain the power flow analysis than mat lab.*

**Key words:** Distributed Generation, Transmission Lines, Loads, Power World Simulator, Matlab.

### **INTRODUCTION**

Traditionally calculations for in-class power system analysis have been done by hand, engineering calculators and/or text-based programming software. Since late 1990s, several teaching approaches for power system analysis using power system simulation software have been developed and some simulators have been utilized in new power system courses. In [1], loads flow and fault analysis of a small-size power system using the Power World simulator software version 10.0 was presented so that students could gain an understanding of the capabilities of this tool and obtain an “animated picture” of a typical power system. In [2], a new power system analysis software program using the C# software and MATLAB software was designed and developed to allow students to enhance their understanding of the power system analysis concepts. Each of software has its own advantages and disadvantages when it is used as an effective learning tool in power system courses. However, in this paper, the Power World software is utilized as a power system analysis tool because of the following reasons:

- It can support very powerful power system visualization techniques such as power flow animation, 3-D display and contouring and map data projections
- Currently it is one of the most commonly used power system simulator by many power utilities and in the electric power industry
- It is relatively easy to teach students how to run simple power system cases and even complex real-life power system cases

In fact, a newly updated version of Power World software supports innovative and advanced visualization techniques that help students better understand what happens in a power system by graphically representing power system data. So this paper introduces new power system visualization techniques such as animation and contouring of power flows and map data projections. This paper also discusses students' evaluation of this course to show that this proposed pedagogical approach using the advanced power system visualization techniques is very effective.

Here we are focusing mainly on animation flow of power system by using power world.

For animation of power flow **creation of one line diagram** must be important.

For animation of power flow **creation of one line diagram** must be important.

### **2. CREATION OF THE ONE-LINE DIAGRAM OF THE POWER SYSTEM**

With this software tool, the students use the provided graphical user interfaces (GUI) to draw the power system being analyzed included in the library are symbols for generator, buses, circuit breakers, transmission lines, and 3-phase loads the model power system for this paper is depicted in fig1. The system consists of 5 132kv buses, 2 generators, 7 transmission lines, 20 circuit breaker and 4 loads. Text fields have been provided to allow for

displaying actual electrical quantities on the one-line diagram .for example , the per unit(PU) voltages and phase angles (degrees)are provided for each voltage bus. The actual power out puts (real and reactive power ) are displayed for each of the generators. The actual power flows (real and reactive power) are provided for all transmission lines. The ratings of the connected load are included on the one-line as well as by careful creation of the power system one-line diagram using power world simulator , the diagram becomes the actual report for describing the results of the simulation

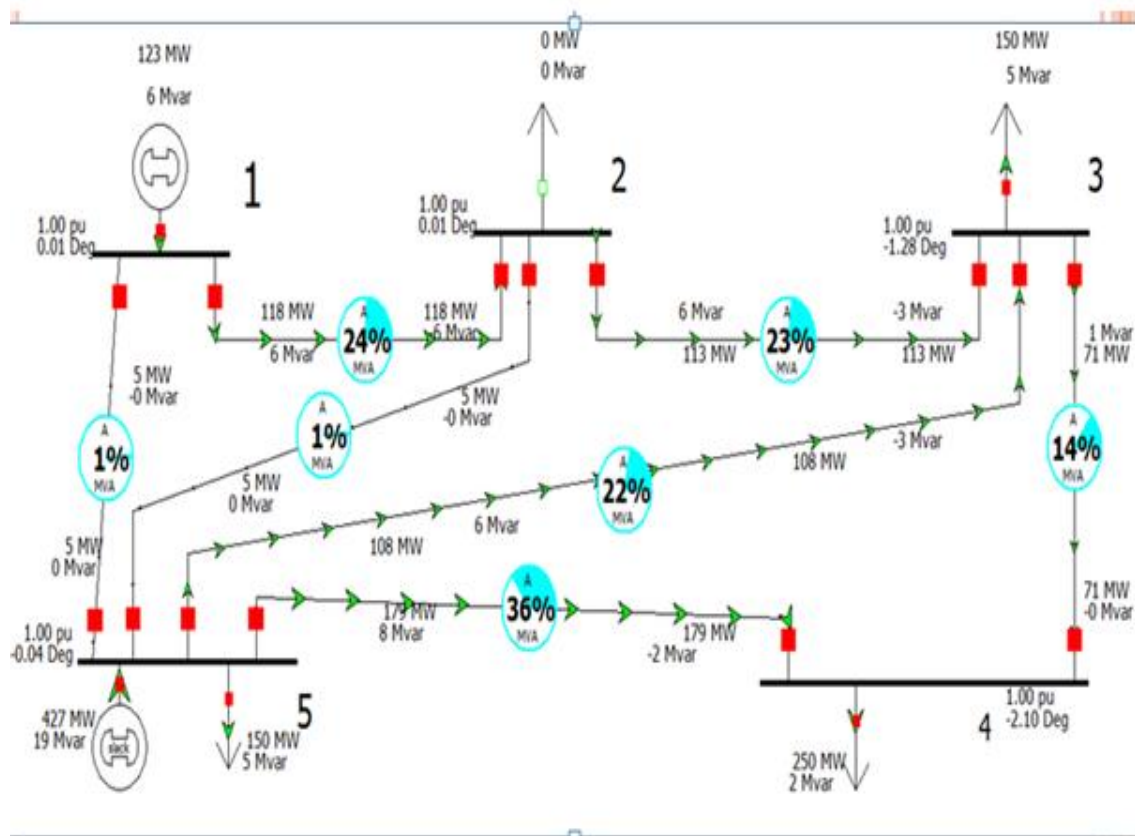

**Fig1 one-line diagram of simulated power system**

**3. POWER FLOW ANALYSIS:**

After the one-line diagram of the power system is completed, the student invokes the simulation menu and chooses the type of load flow (Newton-Raphson, Gauss-Seidel, etc.) to be performed on the network. The appropriate power flow equations are solved and the voltages (magnitude and angle) are determined for each bus. The resulting power flows are shown as triangles, green for real power and blue for imaginary power. The movement of the triangles along the transmission lines depicts actual direction of real and imaginary power flow. The triangles are scaled to show the magnitude of the powers flowing on each transmission line.

**3.1 Power flow analysis when absent of transmission line 1-2:**

Power system one-line diagram when absent of transmission line between 1&2. Animation of power flow when absent of transmission line 1-2 is show in the given fig2.

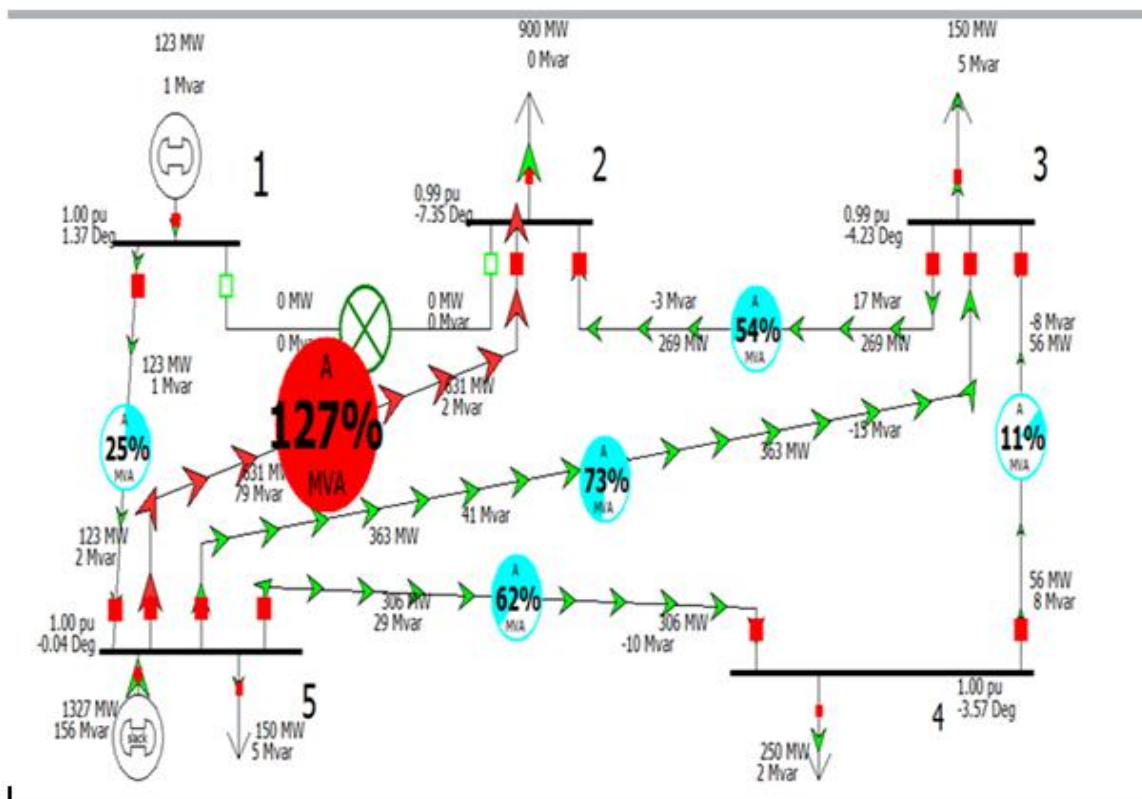

If we disconnect the transmission line between bus 1 & bus 2 that transmission line loading is shared by remaining transmission lines. In this diagram transmission line between the bus 2&5 is over loaded, that is indicated with red color. Due to this 59% is increased in the transmission line between 2&5. So that transmission line may lead to melt or break. Similarly remaining transmission lines diagrams are given below.

### 3.2 power flow analysis when absent of transmission line 2-3:

Power system one-line diagram when absent of transmission line between 2&3. Animation of power flow when absent of transmission line is show in the given fig3.

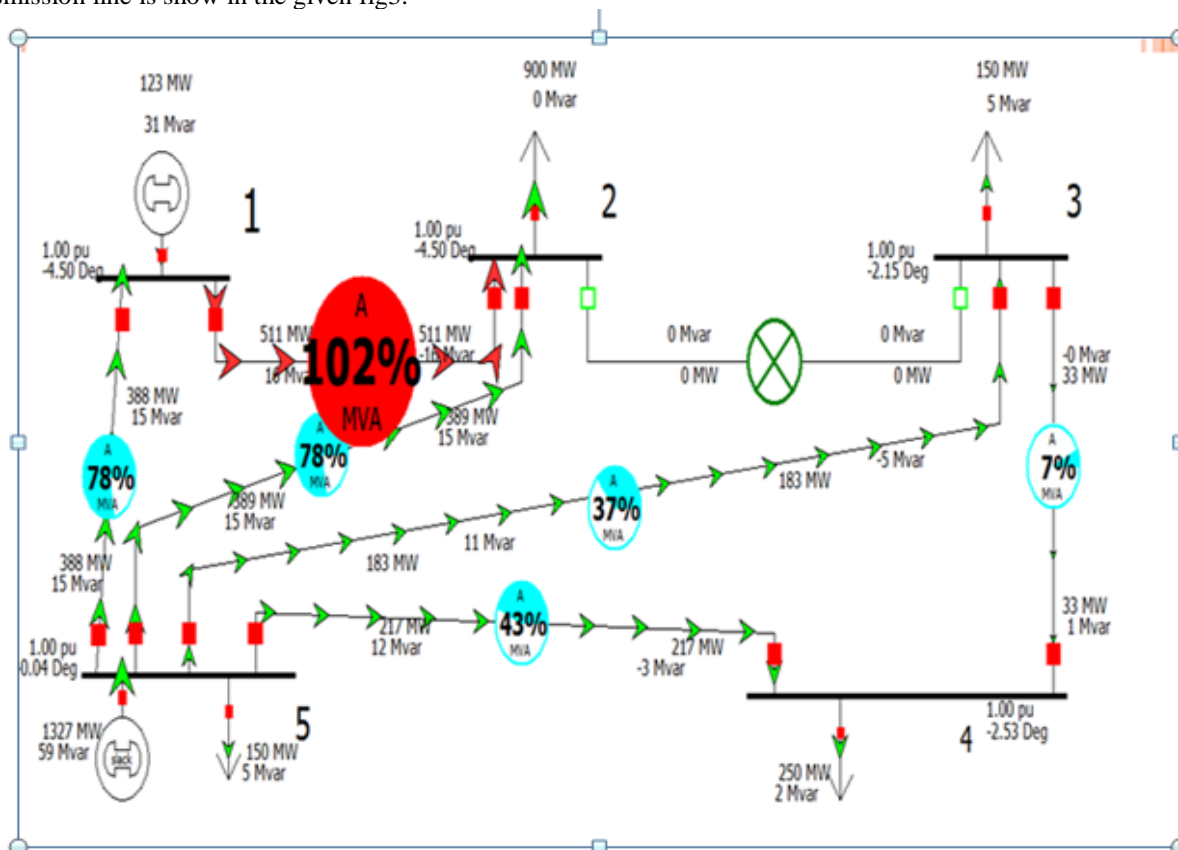

**3.3 power flow analysis when absent of transmission line 3-4:**

Power system one-line diagram when absent of transmission lines between 3&4. Animation of power flow when absent of transmission line is show in the given fig4.

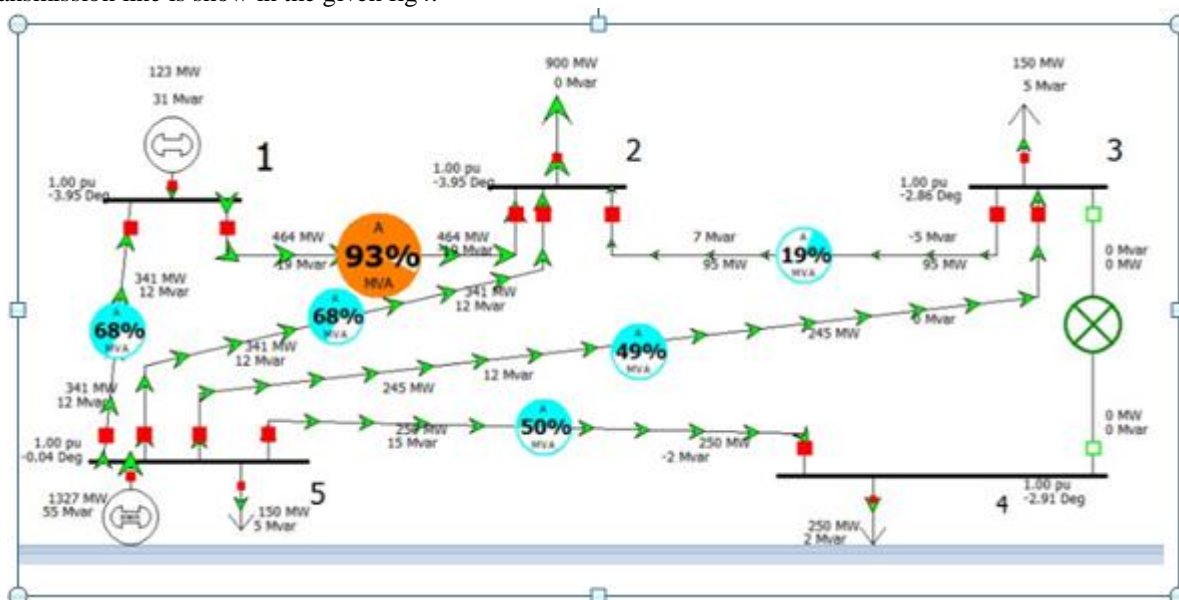

**3.4 power flow analysis when absent of transmission line 4-5:**

Power system one-line diagram when absent of transmission line between 4& 5. Animation of power flow when absent of transmission line is show in the given fig5

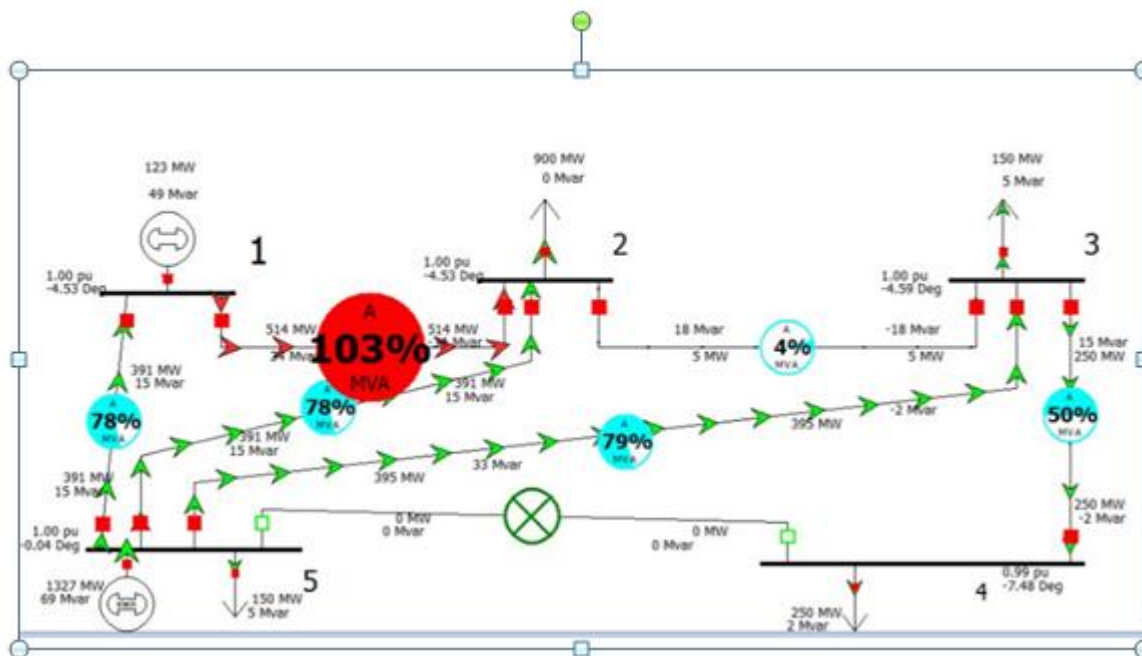

**3.5 power flow analysis when absent of transmission line 5-1:**

Power system one-line diagram when absent of transmission line between 5& 1. Animation of power flow when absent of transmission line is show in the given fig6.

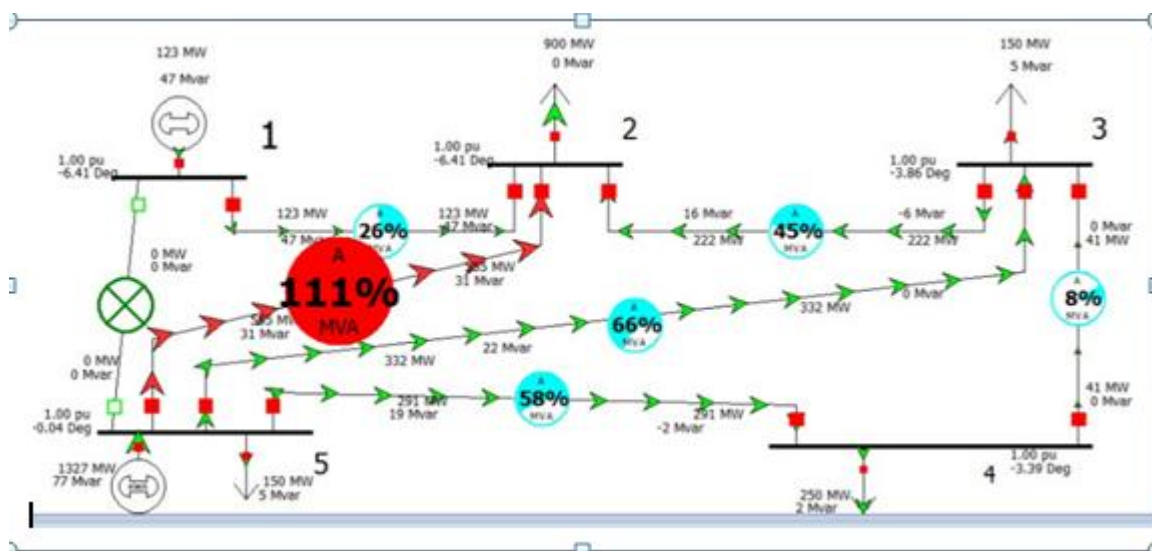

**3.6 power flow analysis when absent of transmission line 5-2:**

Power system one-line diagram when absent of transmission line between 5& 2. Animation of power flow when absent of transmission line is show in the given fig7.

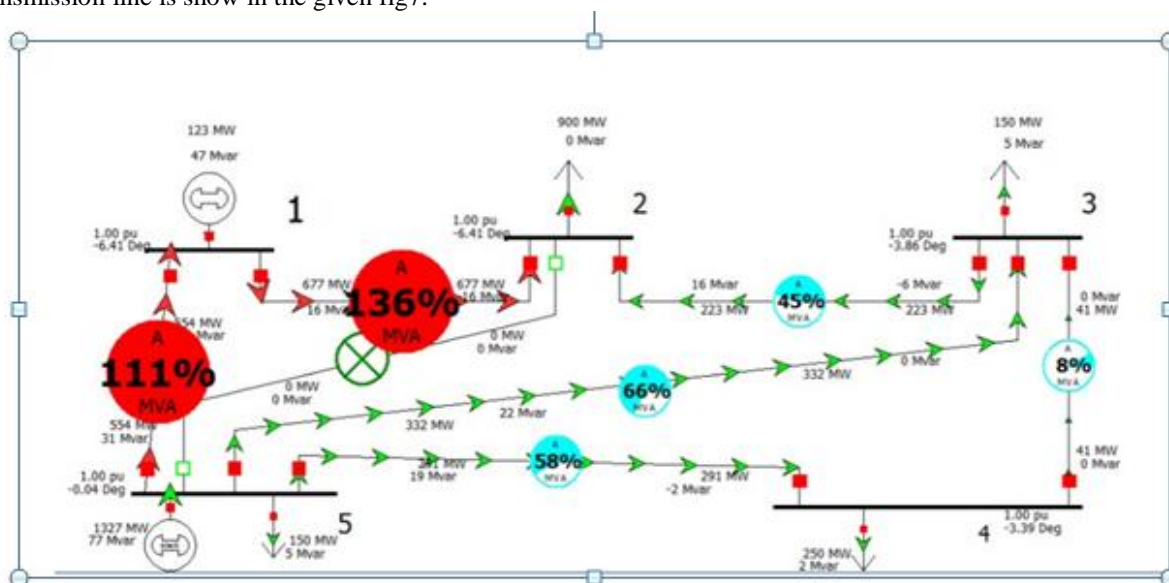

**3.7 power flow analysis when absent of transmission line 5-3:**

Power system one-line diagram when absent of transmission line between 5& 3. Animation of power flow when absent of transmission line is show in the given fig8.

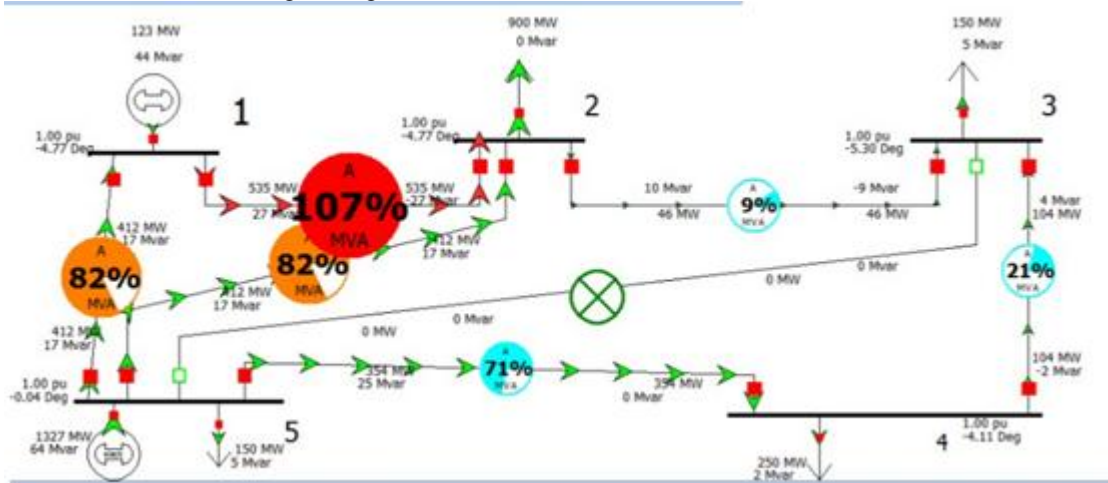

For example bus 2 is considered for Industrial purpose and bus 3 is considered for Government Offices and bus 4 is for House Hold purpose. In general 50 to 60 percent of power supply is sufficient for house hold purpose. Coming to the Government Offices before 9am & after 5pm there is no need to supply power. In those periods that power is transferred to the Industrial. Because Industrials consuming more Electrical Energy in today Marketing Scenario. Like this power management also done by using power world. Not only power flow analysis but also contingency analysis , fault analysis , Transient Stability analysis also determined by using power world.

**4. Contingency analysis:**

A reliable, continuous supply of electrical energy is an essential part of today’s complex societies. Power system network consist of equipment like generators, transformers, transmission lines, circuit breakers etc. Failure of any of this equipment during its operation harms the reliability of the system and hence leading to outages. Therefore, one of the major aim of power system planning and its operation is to study the effect of outages in terms of its severity . All over the world, countries are expanding their power system networks in other to meet up with developmental challenges and this is accompanied by increased Contingencies referring to disturbances such as transmission element outages or generator outages which may always cause sudden and large changes in both the configuration and the state of the system. Contingencies may result in severe violations of the operating constraints. Consequently, planning for contingencies forms an important aspect of secure operation

The purpose of contingency analysis is to analyse the power system in order to identify the overloads and problems that can occur due to a "contingency". This is an abnormal condition in electrical network. It puts the whole system or a part of the system under stress. It occurs due to sudden opening of a transmission line, generator tripping, sudden change in generation and sudden change in load value. Contingency analysis provides tools for managing, creating, analysing, and reporting lists of contingencies and associated violations in a power system . In the year 2014, Nigeria witnessed a lot of activities in the electric power sector, with reforms being at the core of such activities, but the national grid has remained a weak link along the value chain due to constant obstructions like failure of equipments which do cause overloads to other equipments and this has been complicated with transmission line expansions not being adequately planned . There is need to establish a proper study on the probable contingencies in the system, as a tool for power system planners and operation engineers thereby breaching the gap in the knowledge of power system contingency and reliability planning.

Contingency Analysis:

Table 1.0 General contingency analysis when no contingency is present in the network

Label	Skip	Category	Processed	Solved	Post-CTG ALX	Isolated Load	Isolated Gen	Global Actions	Transient Actions	Remedial Actions	QV Autoplot	Custom Monitor Violation	Violation Max Branch %	Min Volt	Max Volt	Max Interface %	Memo
1_0000011-0000049C1	NO		YES	YES	none			0	0	0	NO	0	1	127.2			
2_L_0000011-0000055C1	NO		YES	YES	none			0	0	0	NO	0	1	111.1			
3_L_0000022-0000033C1	NO		YES	YES	none			0	0	0	NO	0	1	102.3			
4_L_0000055-0000022C1	NO		YES	YES	none			0	0	0	NO	0	2	135.5			
5_L_0000023-0000044C1	NO		YES	YES	none			0	0	0	NO	0	0				
6_L_0000055-0000033C1	NO		YES	YES	none			0	0	0	NO	0	1	107.1			
7_L_0000055-0000044C1	NO		YES	YES	none			0	0	0	NO	0	1	109.0			
8_G_0000011U1	NO		YES	YES	none			0	0	0	NO	0	0				
9_G_0000055U1	NO		YES	YES	none			0	0	0	NO	0	1	256.1			

**Transmission Line Contingency Test**

After running the network at base case, a contingency was inserted into the network to check the performance during outage/failure of the components (generators and transmission line). The first contingency that was inserted was the

transmission line contingency test and the effect on the network is given in the table 1.1 below. From the table, it shows that a total of 2 contingencies were performed, giving rise to 8 violations. 1 violation was recorded on the transmission line with high % MVA limit, while 7 violations were recorded on the buses with low limit voltage. The use of contingency selection/screening now helped in singling out those contingencies that led to violations. The contingencies that led to these violations are shown in the table below.

Table 1.1 Transmission line contingency selection/screening of the network

Label	Skip	Category	Processed	Solved	Post-CTG ALUX	Islanded Load	Islanded Gen	Global Actions	Transient Actions	Remedial Actions	CV Autoplot	Custom Monitor Violation	Violation	Max Branch %	Min Volt	Max Volt	Max Interface %	Memo
1_L_0000011-0000023C1	NO	YES	YES	none				0	0	0	NO	0	1	127.2				
2_L_0000011-0000055C1	NO	YES	YES	none				0	0	0	NO	0	1	111.1				
3_L_0000022-0000033C1	YES	NO	NO	none														
4_L_0000055-0000023C1	NO	YES	YES	none				0	0	0	NO	0	2	135.5				
5_L_0000022-0000044C1	NO	NO	NO	none														
6_L_0000055-0000033C1	NO	YES	YES	none				0	0	0	NO	0	1	107.1				
7_L_0000055-0000044C1	NO	YES	YES	none				0	0	0	NO	0	1	103.0				
8_g_0000011I01	NO	YES	YES	none				0	0	0	NO	0	0					
9_g_0000055I01	NO	YES	YES	none				0	0	0	NO	0	1	256.1				

Table 1.2 contingency analysis when contingencies present in the all equipments present in the network

Label	Skip	Category	Processed	Solved	Post-CTG ALUX	Islanded Load	Islanded Gen	Global Actions	Transient Actions	Remedial Actions	CV Autoplot	Custom Monitor Violation	Violation	Max Branch %	Min Volt	Max Volt	Max Interface %	Memo
1_L_0000011-0000023C1	YES	NO	NO	none														
2_L_0000011-0000055C1	YES	NO	NO	none														
3_L_0000022-0000033C1	YES	NO	NO	none														
4_L_0000055-0000023C1	YES	NO	NO	none														
5_L_0000022-0000044C1	YES	NO	NO	none														
6_L_0000055-0000033C1	YES	NO	NO	none														
7_L_0000055-0000044C1	YES	NO	NO	none														
8_g_0000011I01	YES	NO	NO	none														
9_g_0000055I01	YES	NO	NO	none														

**5. Fault Analysis:**

Faults can be defined as the flow of a massive current through an improper path which could cause enormous equipment damage which will lead to interruption of power ,personal injury, or death. The process of evaluating the system voltage and currents under various types of short circuits is called fault analysis Which can determine the necessary safety measures and the required protection system. The analysis of faults leads to appropriate protection settings which can be computed in order to select suitable fuse, circuit breaker size and type of relay.

When a fault exists within the relay protection zone at any transmission line, a single will trip or open the circuit breaker isolating the faulted line. To complete this task successfully, fault analysis has to be conducted in every location assuming several fault conditions. The goal is determine the optimum protection scheme by determine the fault currents and voltages. In reality, power system can consists of thousands of busses which complicate the task of calculating these parameters without the use of computer software.

There are two types of faults which can occur on any transmission line; in addition, unbalanced faults can be classified into single line-to-ground faults, double line faults and double line-to-ground faults.

Fault analysis of a power system by using power world results are shown below

	Fault Name	Skip	Solved	Fault Object (File Format)	Fault Location	Type for Fault 1	Type for Fault 2	Fault Resistance
1	L_000011-000022C1	NO	YES	Branch '1' '2'	50.0	3PB	SLG	0.000
2	L_000011-000055C1	NO	YES	Branch '1' '5'	50.0	3PB	SLG	0.000
3	L_000022-000033C1	NO	YES	Branch '2' '3'	50.0	3PB	SLG	0.000
4	L_000055-000022C1	NO	YES	Branch '5' '2'	50.0	3PB	SLG	0.000
5	L_000033-000044C1	NO	YES	Branch '3' '4'	50.0	3PB	SLG	0.000
6	L_000055-000033C1	NO	YES	Branch '5' '3'	50.0	3PB	SLG	0.000
7	L_000055-000044C1	NO	YES	Branch '5' '4'	50.0	3PB	SLG	0.000
8	B_000011	NO	YES	Bus '1'		3PB	SLG	0.000
9	B_000022	NO	YES	Bus '2'		3PB	SLG	0.000
10	B_000033	NO	YES	Bus '3'		3PB	SLG	0.000
11	B_000044	NO	YES	Bus '4'		3PB	SLG	0.000
12	B_000055	NO	YES	Bus '5'		3PB	SLG	0.000

**MAT LAB ANALYSIS:**

Above power world diagram is connected in mat lab to analyse the real and reactive power of the busses. The connections of the matlab is similar to the connections of the power world. Here five busses are connected in which two are generator busses and remaining are load busses. Circuit brakers are also connected to provided the protection for each and every equipment. The connected diagram in mat lab is shown below.



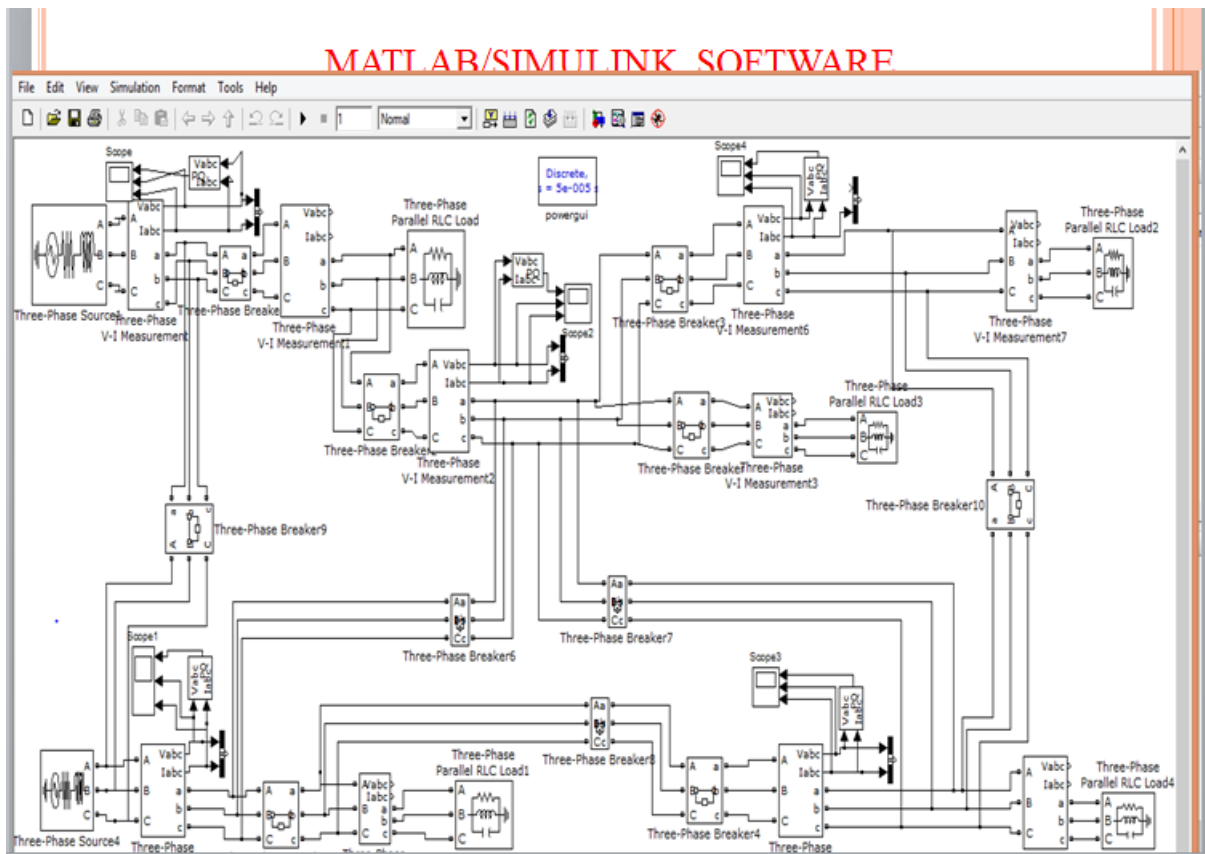

Simulation Results: Results of total real and power taken by load.

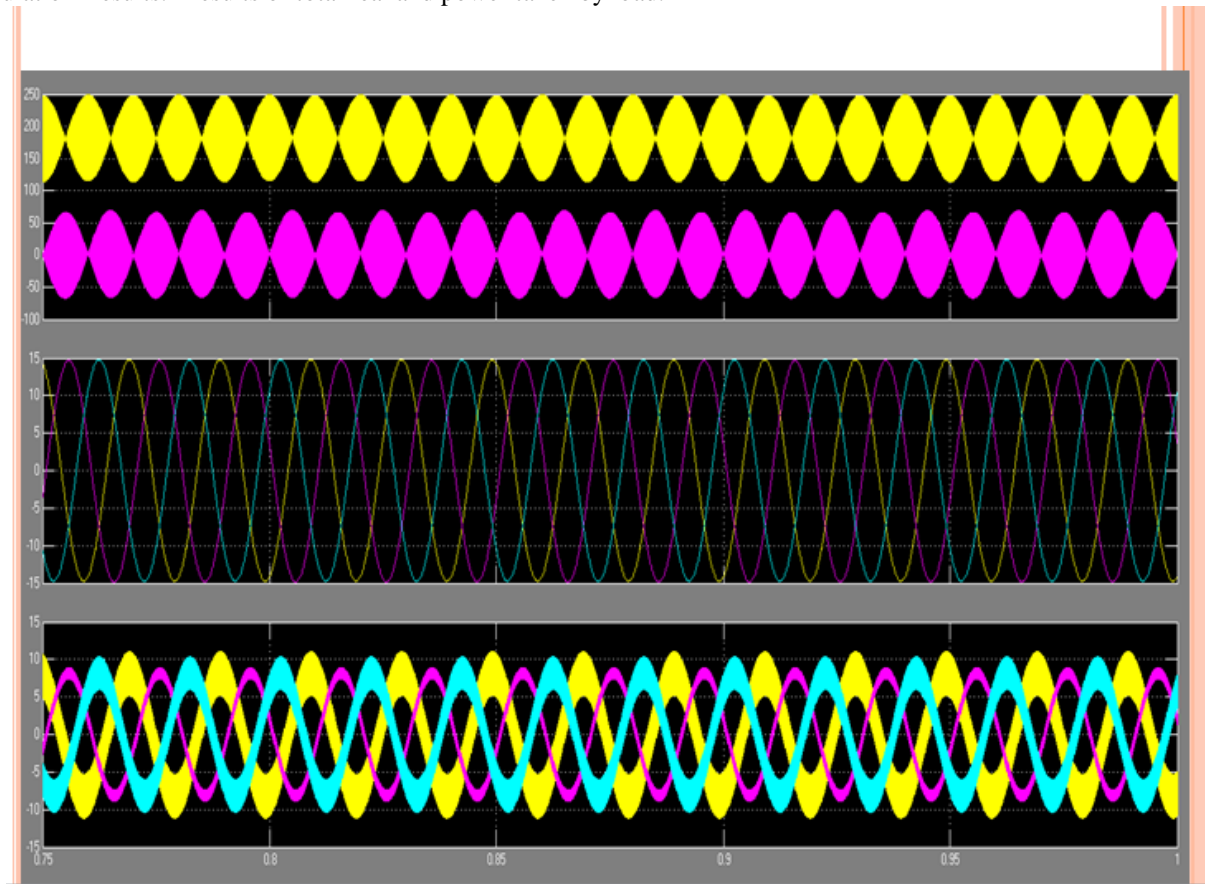

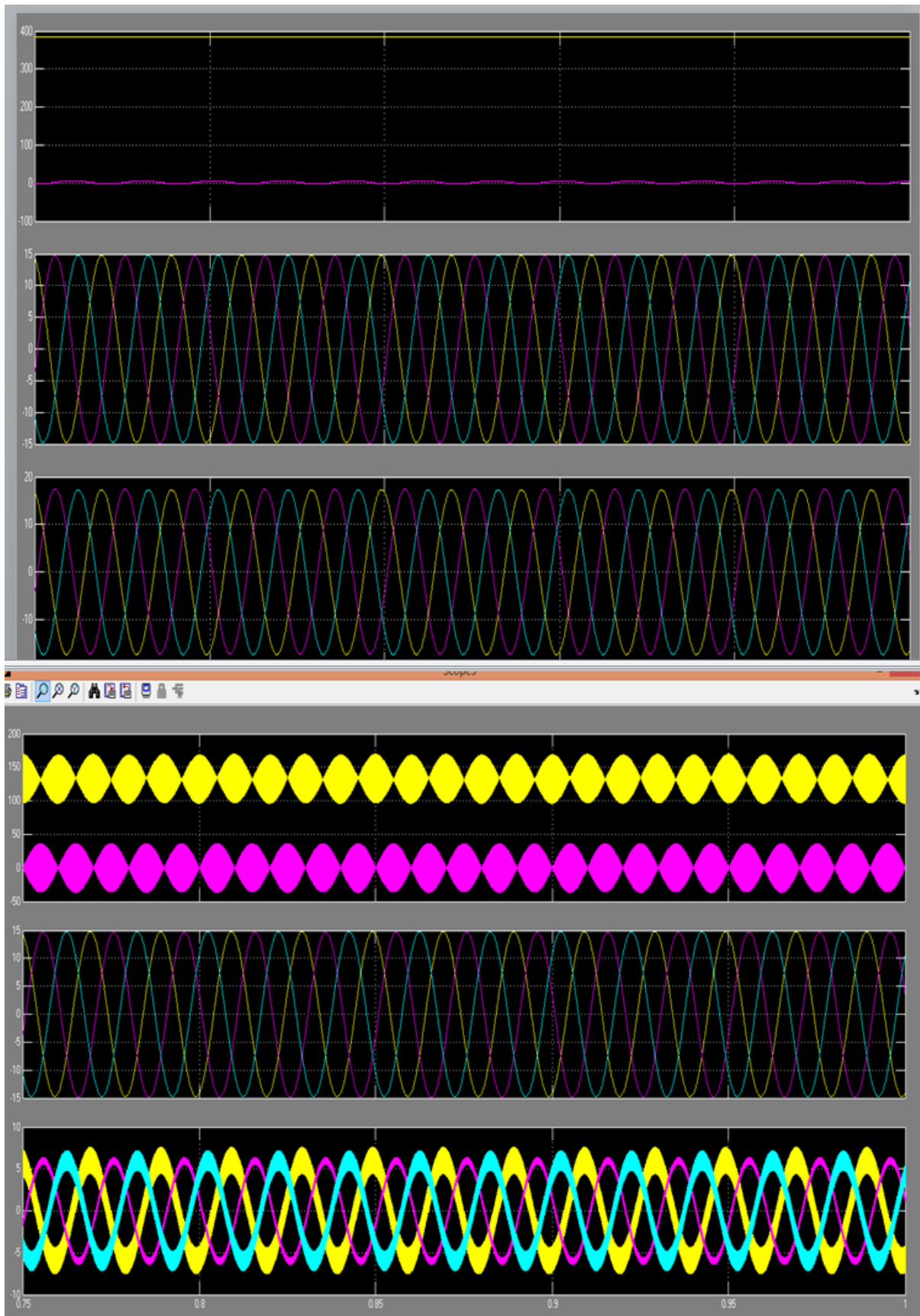

**Future Scope:**

For further advancement of project, the project can be implemented more efficiently by analysing both matlab and power world. With this controlling is made more reliable and security of the system can be increased being more advantageous to the system operation.

## **6. CONCLUSION**

In this paper, we are presented a load flow and contingency analysis of a simple 5 bus power system using a new software tool power world simulator. The simulator tool greatly enhances the students ability to visualize power flows and outages and fault current contributions in a power system network. the presented analysis was created using the student version of power world simulator that is limited to 12 buses. The full version is relatively inexpensive and gives the user the capability to model much larger and complex power system networks.

## **7. REFERENCES**

1. Mrs veenavatijagadishprasad ,mishra&prof.manishad.khardennis , “contingency analysis of power system 2012 IEEE students conference on electrical, electronicsaand computer science, 2012.
2. Paul M. Anderson, “Analysis of faulted power system”, the institute of electrical and electronics engineers, Inc. 1995.
- 3.Sandeepkaur, Dr .Raja singhhela, “ power system design and stability analysis” , international journal of advanced research in computer science and software engineering, volume4, Issue1, journal 2014.
4. Jun Zhu. “analysis of transmission system faulted the phase domain”, Texas A&M university. Master this, 2014.
5. T. K Nagsarkar and M.s sukhija , “power system analysis”, New York oxford university press, pp.14-25,2005.
6. Miroslar D. markovic, “faulted analysis in power system by using the fortescue method”, TESLA institute, 2009.
7. Norliana B. salimum. “phase coordinates in faulted power system analysis”,universityTeknologi Malaysia. Master thesis, 2010.