

## **Water Supply System Design**

ASHALESHA CHAVAN<sup>1</sup>, SHITAL MEHETA<sup>2</sup>

<sup>1</sup>CIVIL ENGINEERING GSFC UNIVERSITY, ashaleshaveera123@gmail.com

<sup>1</sup>CIVIL ENGINEERING PARUL UNIVERSITY, mahetashital93@gmail.com

**Abstract—** *potable water distribution systems are broken into major and minor distribution networks. Major water distribution networks refer to large-scale municipal pipe systems extending from the treatment plant to the upstream node of the water service line for buildings. Minor water distribution systems, referred to as plumbing water distribution systems, run from the upstream node of the water service line to all interior plumbing fixtures and demand nodes associated with the building. Most texts and research papers focus on major systems, while only a small number of documents are available concerning the design and analysis of minor systems. In general, the available minor system documents are quite prescriptive in nature. This paper presents a comprehensive evaluation of contemporary plumbing water distribution system, Drainage and rain Water systems. All underlying theory is explained and advantages and drawbacks are discussed. Issues have been raised regarding the accuracy of water demand estimation procedures for water supply systems,. Demand estimates are crucial for designing underground water supply systems.*

**Keywords—** *Water Supply , Pumping , Distribution System , Valves , Pumps*

### **I. INTRODUCTION**

Plumbing – The pipes , fixtures and other apparatus inside a building for bringing in the water supply and removing the liquid water borne wastes and collecting , disposing Rain water.

Plumbing system – The plumbing system shall include the water supply and distribution pipes, plumbing fittings and traps, soil , waste, vent pipes and anti-siphonage pipes, building drains and building sewers including their respective connections, devices and appurtenances within the property lines of the premises and water treating and water using equipments .It also includes rain water collection and disposal.Recently, vertical expansion of buildings is becoming inevitable in urban areas as the space of human living is steadfastly presenting challenges to the planners and designers due to population explosion.The services like water supply, building drainage & Rain water system become not only complicate but also costly as the height of structure increases.Lastly from few past decades there has been much concern over the high cost of plumbing services for buildings. The main reasons for this are being out of date bye- laws, lacks of research, and reluctances of local authority to take advantage of recent developments Water supply & sanitary engineering.It is necessary to find methods that are socially acceptable, financially affordable and environment friendly to provide long term access to qualitatively and quantitatively safe drinking water with easiest means of supply

### **II. ABOUT WATER SUPPLY SYSTEM STUDY**

Low rise building (Apartments) is selected for Evaluation study of plumbing system (water supply, drainage & rain water), which is situated Nr. Atladara ,Vadodara whose key plan is shown in Figure & its photograph is also shown in fig.1

It is the combination of 12 towers (Tower no 13 to Tower no 24). Phase-I is a cluster of low rise building with the combination of 12 towers (Tower no 1 to Tower no 12). Tower no 13( A & B) Project is selected for Detailed Evaluation Study of Plumbing system because it is consisting of 56 Flats and 15 Shops on Ground Floor & 15 Shops on 1st Floor .i.e. This Tower is a Combination of Commercial and residential Building.Tower no 13 A consist of 6 Shops on ground floor & 6 Shops on 1st floor, While at ground floor parking is on backside.It also consist of 3 Flats on 1st floor and 3 flats on 5th floor ,while on 2nd ,3rd. 4th floors it consist of 6 flats/floor.Tower no 13 B consist of 9 Shops on ground floor & 9 Shops on 1st floor, while at ground floor parking is on backside. It consist of 4 Flats on 1st floor and 4 flats on 5th floor, while on 2nd, 3rd. 4th floor it consist of 8 flats/floor.

This Whole study includes complete observation of Plumbing systems provided on site of Tower no .13 – (A & B).

Also it includes the Calculation of design of plumbing system (Water supply, Drainage & Rain water) and Evaluation w.r.t. plumbing system provided on site.

It includes design capacity of Underground & Over head water tanks w.r.t. demand , design of pumping system .



*Fig. 1 layout & Photographic view of Low-rise Building*

### III. OBJECTIVES OF STUDY

To study the existing Water supply system of Tower 13 (A & B) of project.

To design under ground water tank capacity and evaluate with existing capacity of Tower no 13 (A & B) of project.

To evaluate the existing pumping systems of Tower 13 (A & B).

To suggest modification in the existing systems, if required.

### IV. METHODOLOGY OF STUDY

To achieve objectives of Water Supply System study, following methodology was adopted.

Study of general information Of water Supply System and pumping system is provided in building.

As per existing layout of Water Supply System design of pumping system is worked out.

Design results are compared with existing pumping system.

In case of water supply Actual pressure on site were measured at critical points and compared with worked out design pressure.

It is also compare with minimum required pressure(0.18 Kg/cm<sup>2</sup>) at critical point as per NATIONAL BUILDING CODE OF INDIA for plumbing system

### V. DESIGN OF WATER SUPPLY SYSTEM INDIAN STANDARD: 2065-1983

Water supply in building may be an up feed system whenever the pressure of water in the public main is adequate or a downfeed system whenever the pressure in public main is inadequate.

For building which are more than 25 meters in height consist of pressure reducing valve system, multiple storage system, break pressure tank system, and the hydro pneumatic tank system.

INDIAN STANDARD: 2065-1983

This code deals with water supply in buildings, and covers general requirements and regulations for water supply, plumbing connected to public water supply, licensing of plumbers, design of water supply systems, principles of conveyance and distribution of water within the premises, storage, water fittings and appliances, and inspection and maintenance.

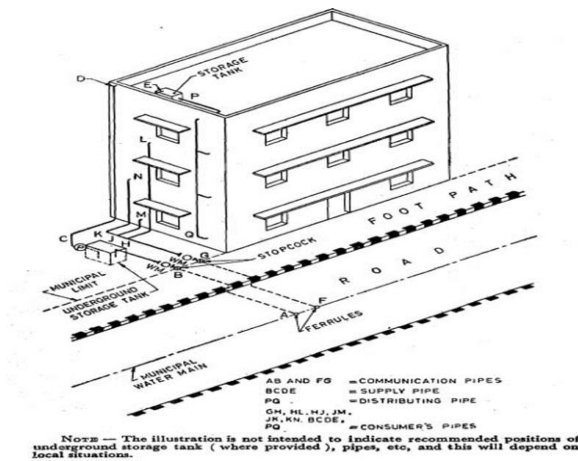

Fig.2 Up feed and down feed Systems

## VI. DESIGN CONSIDERATION

General—Proper design of the water distributing systems in a building is necessary in order that the various water supply faucets may function properly, and there is an adequate supply to meet the needs of the occupants of the building, both with regard to their domestic as well as flushing (of sanitary appliances) requirements.

Note—In general, a daily per capita water consumption of at least 200 liters may be used for most of the large towns and cities in India as design figure to meet domestic and flushing needs. However, for lower income group (LIG) and economically weaker section of the society the value of water supply may be reduced to 135 liters per capita per day.

There shall be at least a residual head of 0.18 Kg/cm<sup>2</sup> at the consumer tap.

Note—the residual head shall be taken at the highest/farthest outlet in the building.

The source of Water supply may be any one or more of the following:

- a) Municipal water supply from mains running near the premises. b) Ground Water Source such as Bore well .

## VII. WATER DISTRIBUTION SYSTEM

Direct Pumping Systems

Hydra-pneumatic Systems

Our Head Tanks Distribution

### Direct Supply System –

This system is adopted when adequate Direct Pumping Water is pumped directly into the distribution system without the aid of any overhead tank, except for flushing purposes. The pumps are controlled by a pressure switch installed on the line. Normally a jockey pump of smaller capacity installed which meets the demand of water during low consumption and the main pump starts when the demand is greater. Then start and stop operations are accomplished by a set of pressure switches arc installed directly on the line. In some installation, a timer switch is installed to restrict the operating cycle of the pump.

Direct pumping systems are suitable for buildings where a certain amount of constant use of water is always occurring. These buildings are all centrally air-conditioned buildings for which a constant make up-supply for air-conditioning cooling towers is required.

The system depends on a constant and reliable supply of power.

Any failure in the power system would result in a breakdown in the watersupply system.

The system eliminates the requirements of overhead tanks for domestic purposes (except for flushing ) and requires minimum space

**Hydro-pneumatic Systems**

Hydro-pneumatic system is a variation of direct pumping system.

An air-tight pressure vessel is installed on the line to regulate the operation of the pumps. The vessel is arranged to consist of approximately half the capacity of water.

As pumps operate, the incoming water in the vessel, compresses the air on top. When a predetermined pressure is reached in the vessel, a pressure switch installed on the vessel switches off the pumps.

As water is drawn into the system, pressure falls into the vessel starting the pump at preset pressure. The air in the pressure tank slowly reduces in volume due to dissolution in water and leakages from pipe lines. An air compressor is also necessary to feed air into the vessel so as to maintain the required air-water ratio.

There are various types of system available in the market and the designers has to select the system according to the needs of each application.

Hydro-pneumatic system generally eliminates the need for an over head tank and may supply water at a much higher pressure than available from overhead tanks particularly on the upper floors, resulting in even distribution of water at all floors

**Overhead Tank Distribution**

This is the most common of the distribution systems adopted by various type of buildings.

The system comprises pumping water to one or more overhead tanks placed at the top most location of the hydraulic zone.

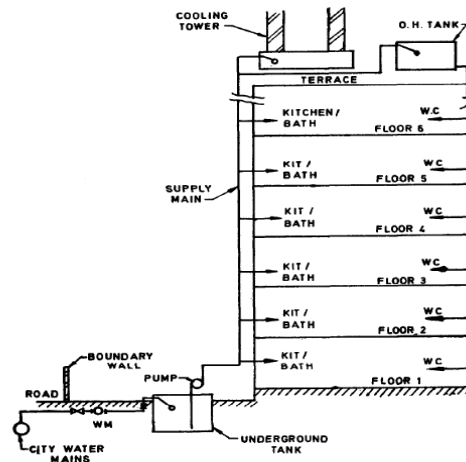

FIG. 2 DIRECT PUMPING SYSTEM APPLICABLE WHERE THERE IS CONTINUOUS DEMAND ON SYSTEM

Fig. 3. Direct Pumping System Applicable Where there is Continues Demand On System

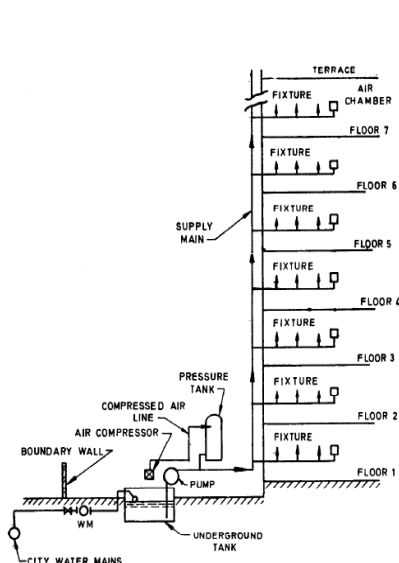

FIG. 3 HYDRO-PNEUMATIC SYSTEM

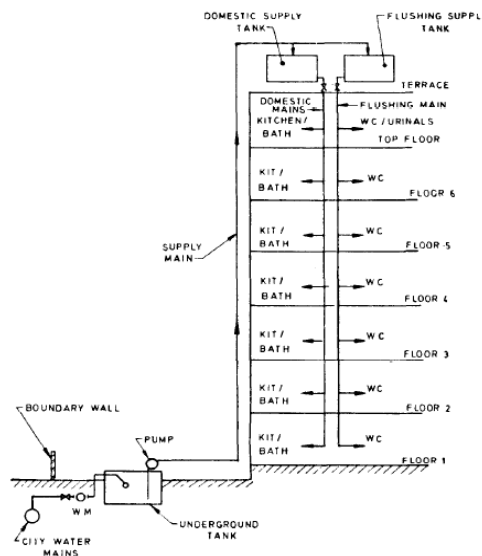

FIG. 4 OVERHEAD TANK DISTRIBUTION

Figure.4. Hydro-pneumatic System

## VIII. OVER HEAD TANK DISTRIBUTION

Design of down feed system:

Procedure followed is:

Estimate the total fixture units.

Ascertain the minimum terminal pressure at the critical fixtures.

Ascertain the pressure available in municipal main.

Estimate development length, equivalent length of the pipe up to critical fixtures.

Estimate static head.

Permissible head loss due to friction.

Estimate the pipe diameter

Suction tank capacity at ground.

Over head storage tank capacity.

Size of riser and head loss in friction

H.P. of pump

## IX. FIELD STUDY

For the evaluation study of plumbing system of Tower 13 A& B of project is considered which is situated near Atladara village, whose front view is shown in photograph 5.1.

Tower 13 (A & B) consist of 5 floors.

At ground floor 6 Shops are provided in Tower 13 –A and 9 Shops are provided in Tower 13 B, while on back side parking is provided .

At first floor of Tower 13- A 6 Shops are provided and 9 shops are provided in Tower 13 –B on front side and on back side parking is provided.

On back side of first floor Tower 13-A, 3 flats are provided in Tower 13-B, 4 Flats are provided.

On 2nd, 3rd& 4th floor 6 Flats per floor are provided in Tower 13-A and 8 Flats per Floor are provided in Tower 13 –B.

On 5th Floor of Tower 13 A it consist of 3 Flats on Back side and 4 Flats in tower 13 –B backside respectively.

Each flat is having area of about 100.5 m<sup>2</sup>.

The height of shops at ground floor is 3.96m, while height of every Floor is 3 m.



*Figure.5. Front View of Tower No.13 A &B*

## **WATER SUPPLY**

Source of water supply – Municipal Corporation & bore well

Timing of availability of corporation water – 7.00 AM TO 8.00 AM (1 hour)

Operation of bore well – automatic, manual

Capacity of underground tank provided on site:

Tank -1(13-A) : (L x B x D)= 4.77 m X 2.74 m X 2.13m = 26,520 liters (26.52 m<sup>3</sup>) ( i.e. at site it is around 271.8m<sup>3</sup> tank is provided but one baffle wall of size 0.665m<sup>3</sup> is placed ,so above value is obtained deducting it.)

Tank -2 (13-B): (L x B x D) = 3.04 m x 2.74 m X 2.13 m =17,325 liters (17.32 m<sup>3</sup>)

Capacity of Over head Tank provided on site:

Tank -1 (13-A): (L x B x D) (4.72 m X 1.97 m X 2.13 m) = 18,410 liters (18.410 m<sup>3</sup>)

Tank -2 (13-B): (L x B x D) = (4.08 m X 1.97 m X 2.13 m) =15,914 liters (15.91 m<sup>3</sup>)

Tank -3 (13-B):(L x B x D):(4.08 m X 1.97 m X 2.13 m)= 15,914 liters (15.91 m<sup>3</sup>)

Now, Tank -1 and Tank-2 both are interconnected on tower 13-B, so total capacity of both of them is 31,828 liters and as per demand, we require only 26,520 liters so 5308 liters is surplus.

Discharge of submersible Pump provided in Underground Tank for pumping water from U.G. Tank to Over head Tank for Tower no 13 A -1.88 liters/sec.(i.e. 6768 ≈ 6700 liters/hr. measured on site )

Discharge measured at O.H. tank direct from bore well- 0.83 liters/sec.(i.e. 2988 ≈ 3000 liters/hr. measured on site)

Discharge of Bore well at ground level-1.2 liters /sec. .(i.e. 4320 ≈ 4000 liters/hr. measured on site)

Discharge of corporation water at Ground level-0.625 liters/sec(from one connection. i.e.2250 liters/hr. measured on site)

Nos. of Connections of Municipal water supply in one tank – 04. (underground)

But on site only 2 connections are kept open for discharging corporation water.

Therefore Discharge of Municipal Water supply in U.G. tank of Tower no. 13-A & B = 2 × 2250 i.e. = 4500 liters/hr.

Diameter of Municipal corporation water supply pipe (Internal) – 06inch (i.e. 160 mm Ø)

Diameter of Municipal corporation water supply line (After ferrule to underground tank Tower no 13 A & B) – 02 inch(50 mm Ø)

Diameter of water supply Down take pipes (5th, 4th Floor) -1.5 inch. (40 mm Ø O.D.) Upvc.

Diameter of water supply Down take pipes (3rd, 2nd ,1st floor) – 1.25 inch(32 mm Ø).

Diameter of rain water pipe – 04 inch (110mm Ø O.D.)

Diameter of Soil pipe & Waste pipe – 04inch (110mm Ø O.D.)

Pipes use for water supply for individual flats- Cpvc (chlorinated polyvinyl chloride).

Upvc (unplasticized polyvinyl chloride)

There are two supply pipes of 2 ½ inch dia.(63 mm Ø) overhead tank to loop/ring forming on terrace.

Company name of pipe – Supreme

Depth of pump installation from ground - 80feet

Available water – 150 feet below ground level

The water is collected in underground tank from bore well and then with the help of submersible pump water is transported to overhead tank.

There are two down take pipes for each flat, one for kitchen and other for toilet shown in fig.

Therefore, total nos. of water supply down take pipes for tower no.13-A are 12 & for Tower no. 13-B are 16 .

Also Instant gizzer system is provided in each toilet, which is of 05 liter capacity.

Also R.O system is provided in individual flats.



*Fig.6 Over Head Water Tank (Actual)*



*Fig.7. Underground Tank with ball valves*

#### **X. WATER DEMAND CALCULATION**

##### **Water Demand Calculation For Tower no 13 –A**

Ground floor – 06 nos. of shop.

1st floor – 06 nos. of shop.

1st floor – 03 nos. of flats.

2nd floor – 06 nos. of Flats.

3rd floor – 06 nos. of Flats.

4th floor – 06 nos. of Flats.

5th floor - 03 nos. of Flats.



Total nos. of shops – 12 nos.

Total nos. of Flats – 24 nos.

Considering 05 persons per dwelling unit area (as per IS: 12183 part-I)

Therefore, total nos. of persons for tower 13-A =  $24 \times 5 = 120$

Water demand = 150Lpcd (as per IS: 1172-1993 code of basic requirements for water supply, drainage and sanitation, 4th revision clause no. 4.1)

Water demand per tower  $120 \times 150 = 18000$  liters/day.

Domestic water Demand for tower 13-A = 18000 liters/day

### **Commercial water demand calculation:**

Total nos. of shops= 12 nos.

Consider 02 persons for more than 15 m<sup>2</sup> of floor area of shop (as per IS: 12183-PART-I- 1987)

One shop area is  $3.35 \times 4.89 \text{ m} = 16.38 \text{ m}^2$

Therefore total no. of persons =  $12 \times 2 = 24$

Water demand = 70Lpcd (as per IS: 1172-1993 code of basic requirements for water supply, drainage and sanitation, 4th revision clause no. 4.1).

Water demand  $70 \times 24 = 1680$  liter/day.

Commercial water demand for Tower 13-A= 1680 liters/day

Therefore total water demand for tower no 13- A (Residential & commercial)

= 19,680 liters/day say 20,000litres/day Approx.

### **Design of Underground Water tank Capacity (Tower no. 13-A)**

Under Ground Tank:

Providing U.G. storage Water tank Capacity =  $1.5 \times$  Total water Demand

=  $1.5 \times 20,000$

= 30,000 liters (30 m<sup>3</sup>)

Provision of Under Ground Water Tank Tower no.13-A is about 26.52 m<sup>3</sup>

(There is a wall in tank of  $4 \frac{1}{2} \times 9' \times 7'$  so volume of tank is calculated as deducting the volume of wall from available volume of tank)

(Source IS: 12183-PART-I- 1987 clause no. 9.2)

### **Overhead Tank**

Providing one day storage capacity of overhead water Tank for Tower 13-A

Therefore, Volume of over head Tank required for tower 13-A = 20,000litres.(20.0 m<sup>3</sup>) Provision of Overhead Water Tank Tower no.13-A is about 18.41 m<sup>3</sup>As per require demand of water provided capacity of O.H. Tank is less.



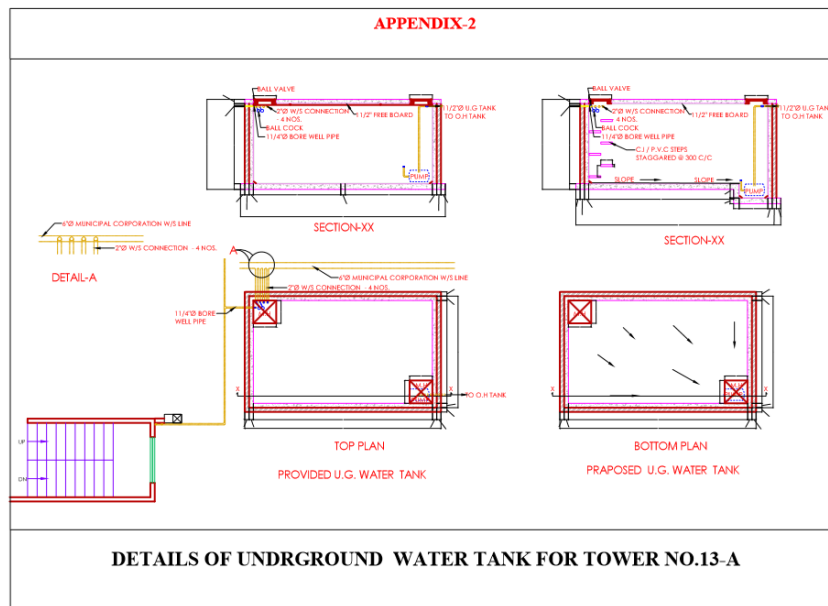

Fig.8. Details of Underground Water Tank

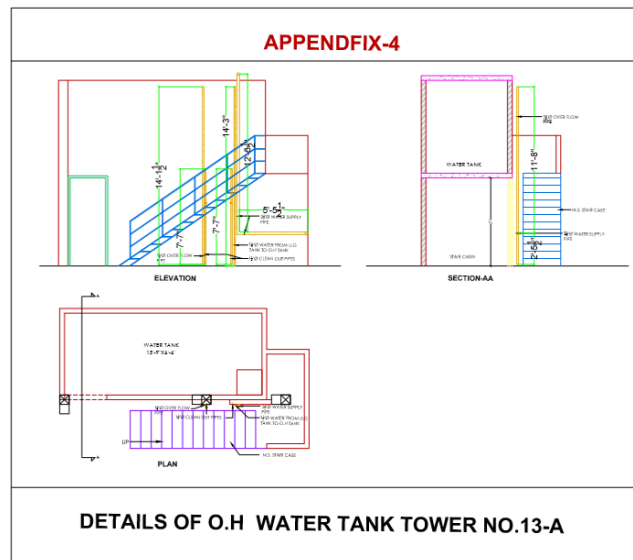

Fig.9. Details of Overhead Water Tank

XI. PUMP DESIGN

Bore well

| Dia D<br>m | Length L<br>m | Discharge Q <sub>1</sub><br>cu.m/s | Q <sub>2</sub><br>lpm | Area A<br>sq.m | V        | hf        | hm       | H         | roughness   | nu       | Rn       | f        | hs    | ht       |       |
|------------|---------------|------------------------------------|-----------------------|----------------|----------|-----------|----------|-----------|-------------|----------|----------|----------|-------|----------|-------|
| 0.04       | 52.07         | 0.0008333                          | 50                    | 0.0012566      | 0.663146 | 0.705711  | 0.011207 | 0.716918  | 1.52393E-06 | 0.000001 | 26525.82 | 0.024187 | 52.74 | 53.44571 | 3000  |
| 0.04       | 52.07         | 0.00125                            | 75                    | 0.0012566      | 0.994718 | 1.444919  | 0.025216 | 1.470135  | 1.52393E-06 | 0.000001 | 39788.74 | 0.02201  | 52.74 | 54.18492 | 4500  |
| 0.04       | 52.07         | 0.0016667                          | 100                   | 0.0012566      | 1.326291 | 2.409823  | 0.044828 | 2.454651  | 1.52393E-06 | 0.000001 | 53051.65 | 0.020648 | 52.74 | 55.14982 | 6000  |
| 0.04       | 52.07         | 0.0020833                          | 125                   | 0.0012566      | 1.657864 | 3.58947   | 0.070044 | 3.659513  | 1.52393E-06 | 0.000001 | 66314.56 | 0.019684 | 52.74 | 56.32947 | 7500  |
| 0.04       | 52.07         | 0.0025                             | 150                   | 0.0012566      | 1.989437 | 4.976129  | 0.100863 | 5.076991  | 1.52393E-06 | 0.000001 | 79577.47 | 0.01895  | 52.74 | 57.71613 | 9000  |
| 0.04       | 52.07         | 0.0033333                          | 200                   | 0.0012566      | 2.652582 | 8.348221  | 0.179312 | 8.527533  | 1.52393E-06 | 0.000001 | 106103.3 | 0.017882 | 52.74 | 61.08822 | 12000 |
|            | LUBI          |                                    |                       |                |          |           |          |           |             |          |          |          |       |          |       |
|            | Head          | Discharge                          |                       |                | CRI      |           |          | Kirloskar |             |          |          |          |       |          |       |
|            | 67            | 0                                  |                       |                | Head(m)  | Discharge |          | Head(m)   | Discharge   |          |          |          |       |          |       |
|            | 66            | 1000                               |                       |                | 63       | 0         |          | 78        | 2400        |          |          |          |       |          |       |
|            | 64            | 2000                               |                       |                | 61       | 900       |          | 72        | 3600        |          |          |          |       |          |       |
|            | 61            | 3000                               |                       |                | 59       | 1800      |          | 63        | 4800        |          |          |          |       |          |       |
|            | 54            | 4500                               |                       |                | 56.5     | 2700      |          | 51        | 6000        |          |          |          |       |          |       |
|            | 47            | 6000                               |                       |                | 54       | 3600      |          | 37        | 7200        |          |          |          |       |          |       |
|            | 37            | 7500                               |                       |                | 49.5     | 4500      |          |           |             |          |          |          |       |          |       |
|            | 27            | 9000                               |                       |                | 41       | 5400      |          |           |             |          |          |          |       |          |       |
|            | 14            | 10500                              |                       |                | 31       | 6300      |          |           |             |          |          |          |       |          |       |
|            |               |                                    |                       |                | 19       | 7200      |          |           |             |          |          |          |       |          |       |

Table.1. Pump Design Bore well

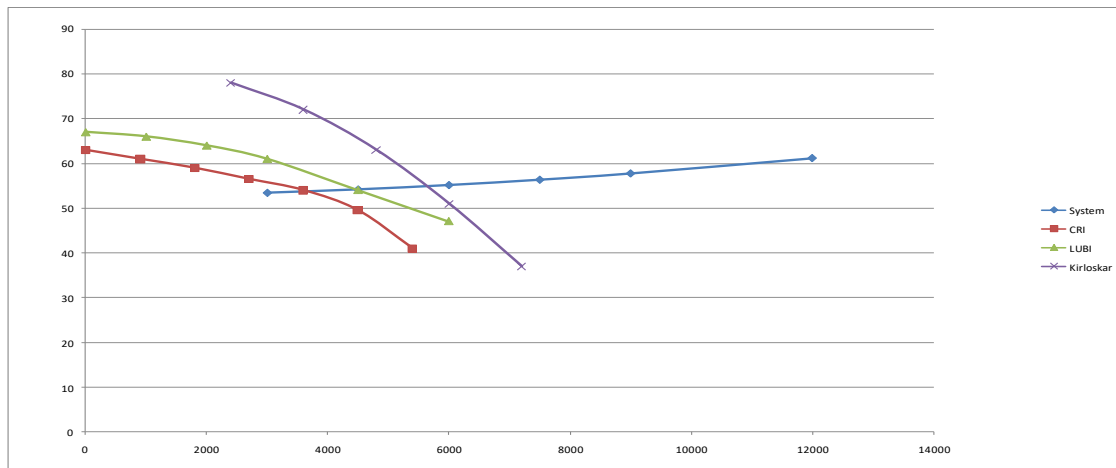

Fig.8.Pump Design System Graph

According to Field discharge as measured i.e. 3000 litres/hr so, considering from above table for required static head i.e. 52 m approx. ,we can recommend LUBI Pump and also on site it is already placed.

**Open Well**

| Dia  | Length | Discharge     | Area | V                | hf       | hm        | H         | roughness              | nu          | Rn       | f         | hs       | ht    | Discharge |       |
|------|--------|---------------|------|------------------|----------|-----------|-----------|------------------------|-------------|----------|-----------|----------|-------|-----------|-------|
| D    | L      | Q             | A    |                  |          |           |           |                        |             |          |           |          |       | Q         |       |
| m    | m      | cu.m/s<br>lpm | sq.m |                  |          |           |           |                        |             |          |           |          |       | lph       |       |
| 0.04 | 24.97  | 0.0008333     | 50   | 0.0012566        | 0.663146 | 0.338421  | 0.011207  | 0.349628               | 1.52393E-06 | 0.000001 | 26525.82  | 0.024187 | 22.26 | 22.59842  | 3000  |
| 0.04 | 24.97  | 0.00125       | 75   | 0.0012566        | 0.994718 | 0.692906  | 0.025216  | 0.718122               | 1.52393E-06 | 0.000001 | 39788.74  | 0.02201  | 22.26 | 22.95291  | 4500  |
| 0.04 | 24.97  | 0.0016667     | 100  | 0.0012566        | 1.326291 | 1.155623  | 0.044828  | 1.200451               | 1.52393E-06 | 0.000001 | 53051.65  | 0.020648 | 22.26 | 23.41562  | 6000  |
| 0.04 | 24.97  | 0.0020833     | 125  | 0.0012566        | 1.657864 | 1.721319  | 0.070044  | 1.791362               | 1.52393E-06 | 0.000001 | 66314.56  | 0.019684 | 22.26 | 23.98132  | 7500  |
| 0.04 | 24.97  | 0.0025        | 150  | 0.0012566        | 1.989437 | 2.386286  | 0.100863  | 2.487149               | 1.52393E-06 | 0.000001 | 79577.47  | 0.01895  | 22.26 | 24.64629  | 9000  |
| 0.04 | 24.97  | 0.0033333     | 200  | 0.0012566        | 2.652582 | 4.003362  | 0.179312  | 4.182674               | 1.52393E-06 | 0.000001 | 106103.3  | 0.017882 | 22.26 | 26.26336  | 12000 |
|      |        | LUBI(MXF152)  |      | CRI(LBB-13E-11M) |          | Kirloskar |           | GRUNFOS(SMART SUBHOSD) |             |          |           |          |       |           |       |
| Head |        |               |      | Head(m)          |          | Head(m)   | Discharge |                        |             | HEAD     | DISCHARGE |          |       |           |       |
| 26   | 1200   |               |      | 26.6             | 0        | 40        | 3600      |                        |             | 12       | 8400      |          |       |           |       |
| 25   | 2400   |               |      |                  | 3600     | 37        | 5400      |                        |             | 16       | 7670      |          |       |           |       |
| 24   | 3600   |               |      |                  | 5400     | 31        | 7200      |                        |             | 19       | 7000      |          |       |           |       |
| 23   | 4800   |               |      | 23.7             | 7200     | 24        | 9000      |                        |             | 22       | 6230      |          |       |           |       |
| 22   | 6000   |               |      | 22.2             | 9000     | 14        | 10800     |                        |             | 26       | 5280      |          |       |           |       |
| 21   | 7200   |               |      | 20.2             | 10800    |           |           |                        |             | 29       | 4360      |          |       |           |       |
| 20   | 8400   |               |      | 18               | 13000    |           |           |                        |             | 32       | 3370      |          |       |           |       |
| 19   | 9600   |               |      | 15.6             | 14000    |           |           |                        |             | 36       | 1730      |          |       |           |       |

Table.2 :Pump Design Open well

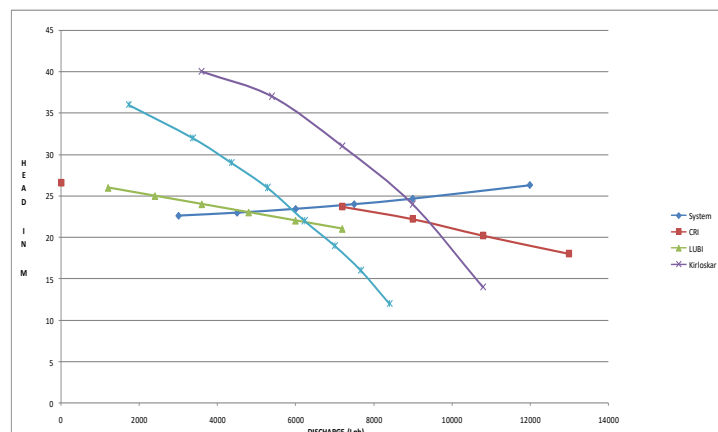

Figure.9. Pump Design System Graph

According to Field discharge as measured i.e. 6800 litres/hr so , considering from above table for required static head i.e. 22 m ,we can recommend LUBI Pump and also on site it is already placed

## XII. CONCLUSION

As per study regarding the documents related to design and drawings of the storage systems till date we don't provide the detail documents to owners for their references while purchasing any their property, which reveals that by providing such authentic documents to owner we can guide them with their own requirements and provisions for their paid amenities. With the above all design part we can conclude that with proper guidance considering the Standard codes and references we can change the design pattern of water storage sumps and even can achieve the great economic.

Some changes like making pits and giving platform arrangement in underground sumps may give space to clean during maintenance with less water wastage.

Also proper designing of pump efficiency will guide for correct pump selection.

Thus this design is completely beneficiary to both contractor as well as owner in all sense.

## XIII. REFERENCES

- [1] NATIONAL PLUMBING CODE HAND BOOK U.S.A. & NATIONAL BUILDING CODE OF INDIA.
- [2] CODE OF PRACTICE FOR WATER SUPPLY IN BUILDINGS BUREAU OF INDIAN STANDARDS  
MANAK BHAVAN, 9 BAHADUR SHAH ZAFAR MARG, NEW DELHI 110002
- [3] IS : 12183( PART-I) 1987. Code of practice for Plumbing in Multi-storeyed Building.
- [4] Standard Plumbing Code( edition 1991)
- [5] National building code-2005 PART 9 PLUMBING SERVICES Section 1 Water Supply, Drainage  
and Sanitation (including Solid Waste Management).
- [6] IS : 2470 ( Part 1 ) - 1985 Indian Standard CODE OF PRACTICE FOR INSTALLATION OF  
SEPTIC TANKS PART I DESIGN CRITERIA AND CONSTRUCTION( Second Revision )